

# 34 AutoCAD Tips

## to Become a Power User

AUTODESK®  
AUTOCAD®

AUTODESK®  
AUTOCAD®

×   RECOVER

A

# 34 AutoCAD Tips to Become a Power User



## ENTER, NEW PLAYER

1. Use Both Hands
2. ToolTips
3. Command Line
4. Grip Editing
5. Quick Measure
6. Selection Cycling
7. Multileader Styles
8. Page Setups

## TAKE YOUR SKILLS TO THE NEXT LEVEL

18. Express Tools
19. Tool Palettes
20. Layer Filters
21. Quick Select
22. Fields
23. AutoCAD Wherever You Go
24. Nonrectangular Viewports
25. Copy Nested Objects
26. Purge and Audit

## UP YOUR GAME

9. Copy and Paste Options
10. Command Options
11. Keyboard Combos
12. Viewports
13. AutoCAD on any Computer
14. Blocks Palette
15. Favorite Places
16. Annotative Scaling
17. DWG Compare

## POWER UP!

27. Alias Editor
28. User Coordinate System
29. Named Views
30. Action Recorder
31. Design Center
32. Draft in AutoCAD across Desktop, Web, and Mobile
33. AutoCAD Specialized Toolsets
34. Make the Winning Moves



⚡ LEVEL 1

ENTER,  
NEW PLAYER

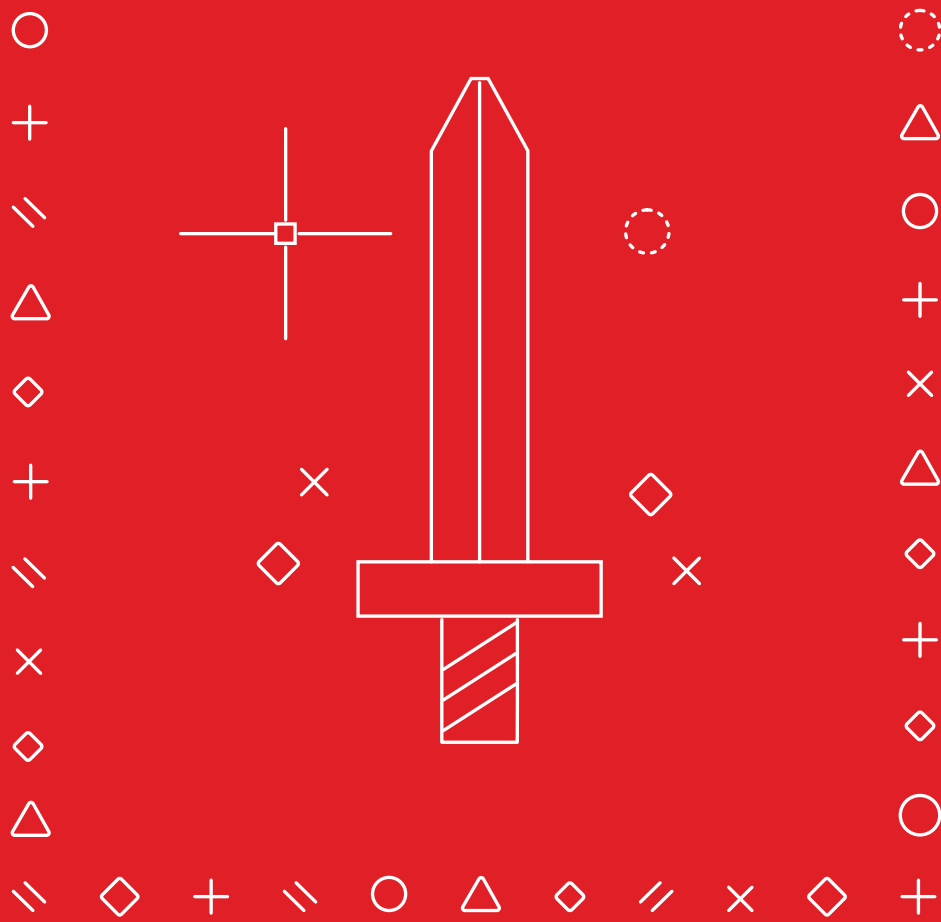

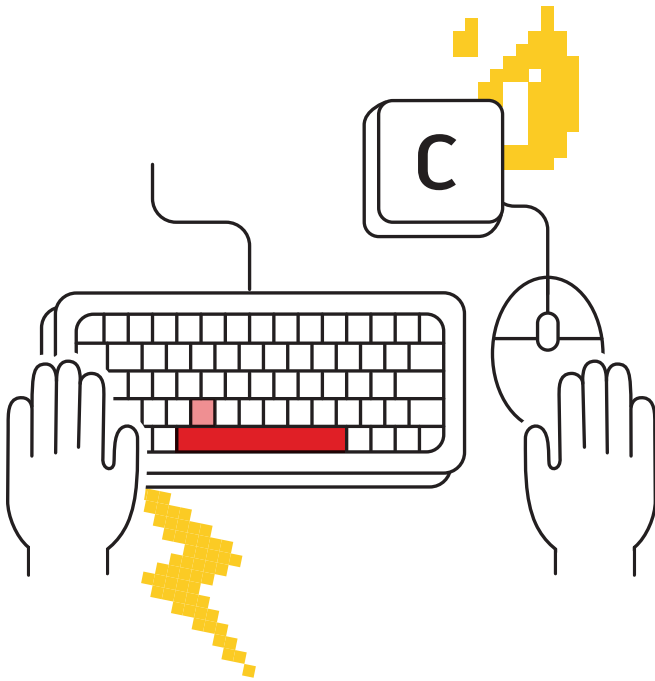

## Use Both Hands

**Keeping your non-mouse hand on the keyboard can increase your productivity by allowing fast access to command aliases and keyboard shortcuts.**

Don't be a mouse-only person; you've got two hands, so use them! Most power users take advantage of how quickly commands can be issued and recalled by keeping their non-mouse hand on the keyboard.

You probably know that Enter acts as a "run previous command" key in AutoCAD, but the Spacebar does the same thing. Need quick access to the circle command? Not only is the two keystroke action of "C" and "Thumb" (spacebar) faster than visually searching for, finding, moving your mouse, and clicking on the Ribbon icon... it allows you to keep your eye on what you're working on, instead of looking away for the icon, then back to your work area – increasing your efficiency.

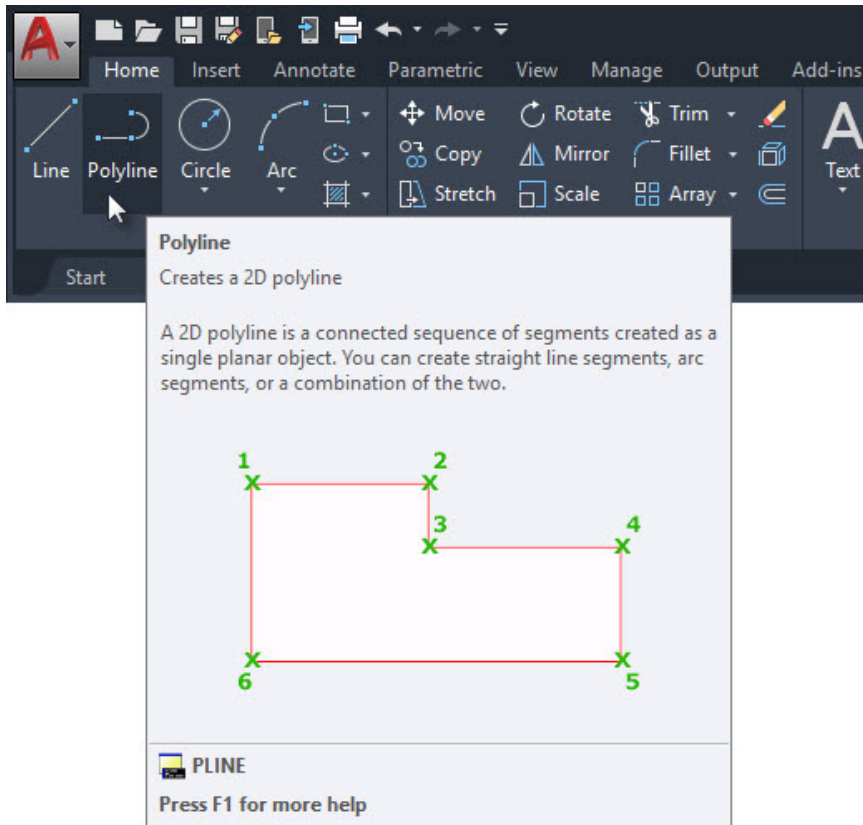

## ToolTips

### Make use of the Extended ToolTips to help you with command input.

Some commands are used more than others in AutoCAD. For the commands you may not use as often, AutoCAD provides a refresher on how they work.

Hovering over the command icon in the Ribbon will display the short ToolTip. Continue hovering and the Extended ToolTip will display. It provides a brief explanation of the command and displays an image showing the proper input sequences you should use. In some cases, especially 3D commands, the image is even animated.

If you feel like the ToolTips display times are too long or too short, you can change them in the Display tab of the Options dialog.

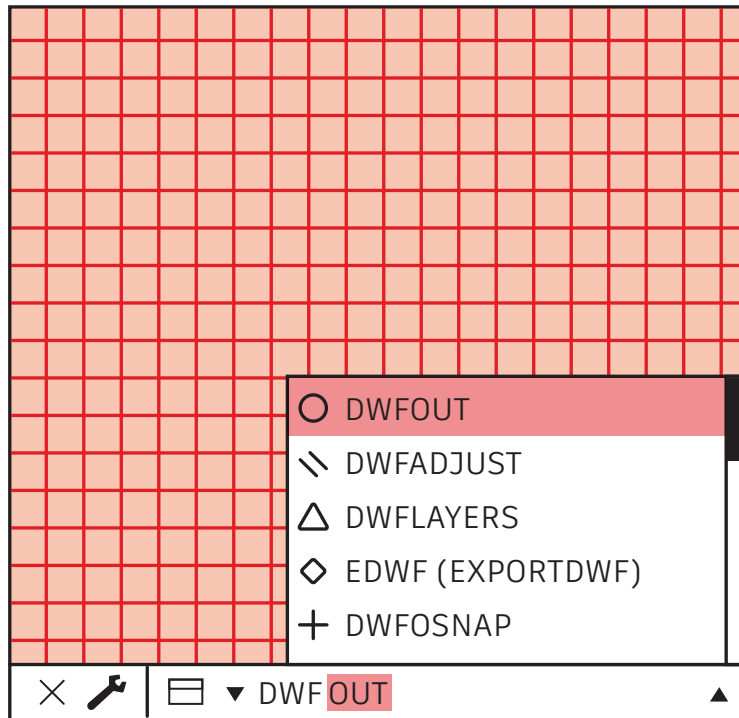

## Command Line

### Improve your productivity by utilizing the powerful search feature of the Command Line.

Let the Command Line work as a search engine when you can't remember a command. If you can remember part of it – what it began with, ended with, or something in between – type it in and let the Command Line display options that match.

For example, you remember the command you need has something to do with DWF's. Just type in DWF, and you'll get all the commands with DWF somewhere in them.

**Bonus Tip:** Are you a bad speller or typist? AutoCAD's Command Line will also learn your mistakes and turn your frequently misspelled commands into the correct version.

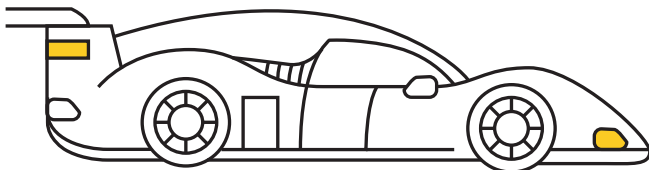
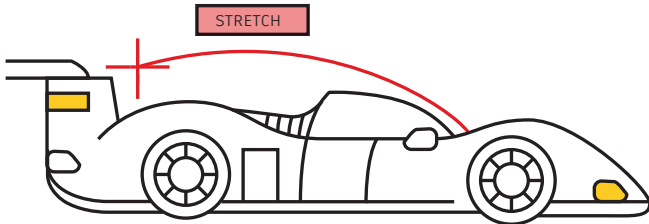
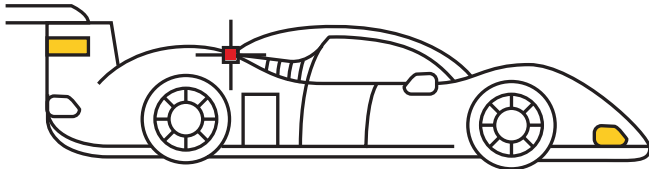

## Grip Editing

**Access common editing tools by using Grips, without launching a command.**

Using Grips to edit objects is often faster than using editing commands. Depending on the object, the default action is usually either Move or Stretch. Hovering over the Grip will display other editing options, if available.

To launch the edit command, either select one from the pop-up list or click the Grip for the default action. Press the Shift key to select multiple Grips.

Once the Grip is activated (a “hot” Grip) you can right click on a selected Grip to access additional options including Rotate, Scale, and Mirror. You can even Copy the object as you edit it, as well as specify a basepoint or reference distance. All of this can be done directly from the selected object without launching a command.

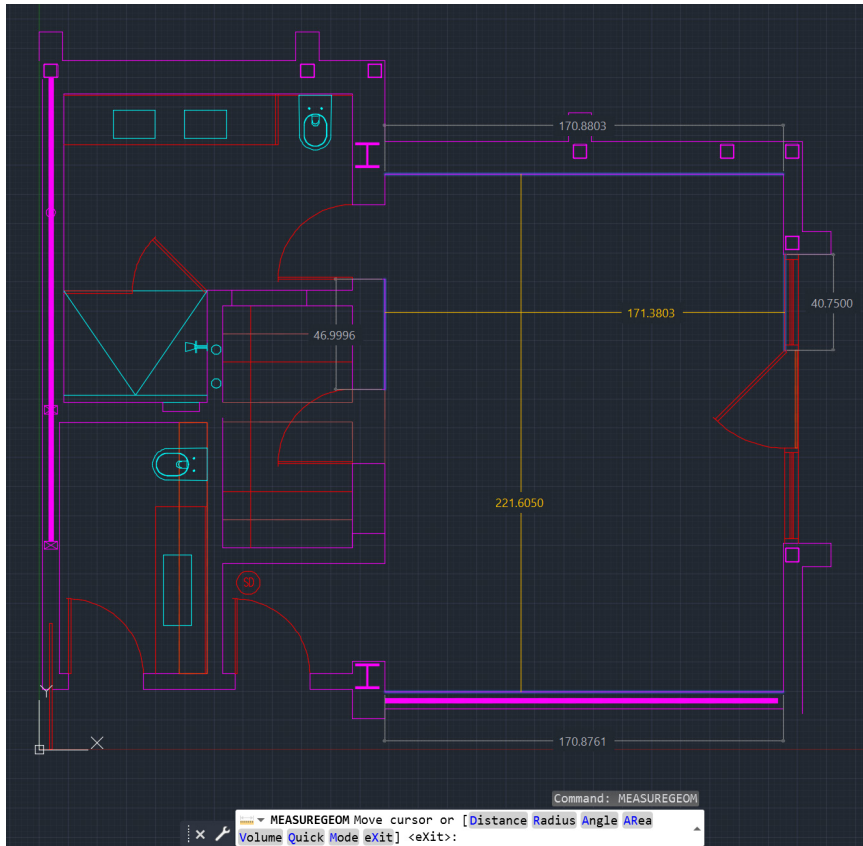

## Quick Measure

**Verify the accuracy of your drawing's geometry at a glance with the new Quick Measure tool.**

When Quick Measure is selected, Dimensions, Distances, and Angles are shown as you move your mouse over and between objects. Small orange squares in corners will indicate that lines are at 90-degree angles.

The dynamic display provides a dramatic improvement over the slower, traditional method of picking individual measurement points.

Verification may now be possible by what you don't see. For instance, the distance between two objects is measured only if the objects are parallel. The right-angle markers will only appear if the objects are truly at 90-degrees to each other.

**Bonus Tip:** To avoid clutter and improve performance when using the Quick Measure tool, it's best to Zoom into complicated areas of your drawing.



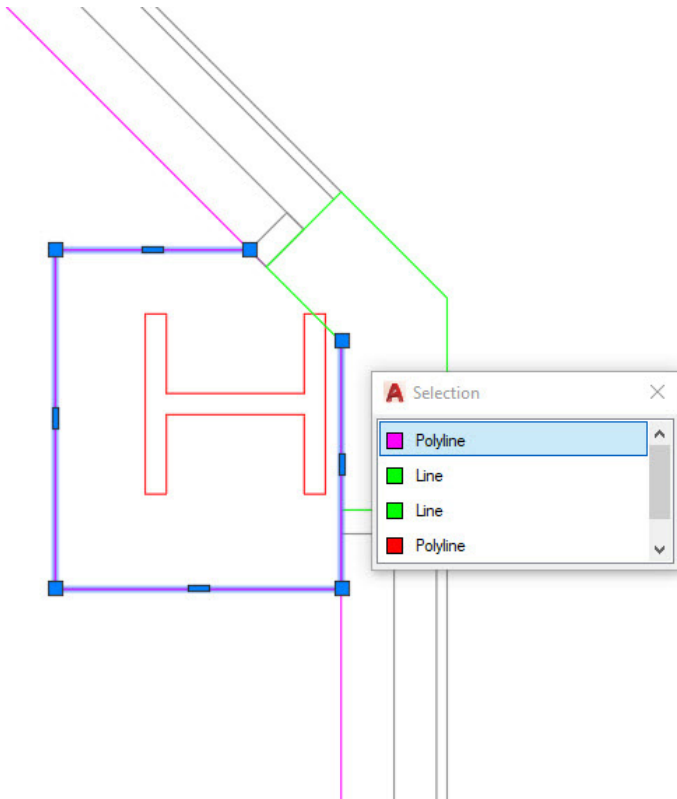

## Selection Cycling

### Improve object selection accuracy by using Selection Cycling.

When Selection Cycling is enabled, and multiple objects are available to select, AutoCAD will display a badge next to your cursor. When you see it, click as if you are selecting, and a selection box will appear with all the objects within your cursor listed. You'll see the object type and its color.

Hover over each item, and the corresponding entity will be highlighted. When you find your desired object, select it from the list. The dialog will dismiss, leaving you with an accurate selection.

Note: Selection Cycling does not display in the Status Bar by default. Click on the Status Bar Customization icon (three horizontal bars on the end) and make sure it is checked. Once displayed, toggle it on (or off) like most other status bar tools.

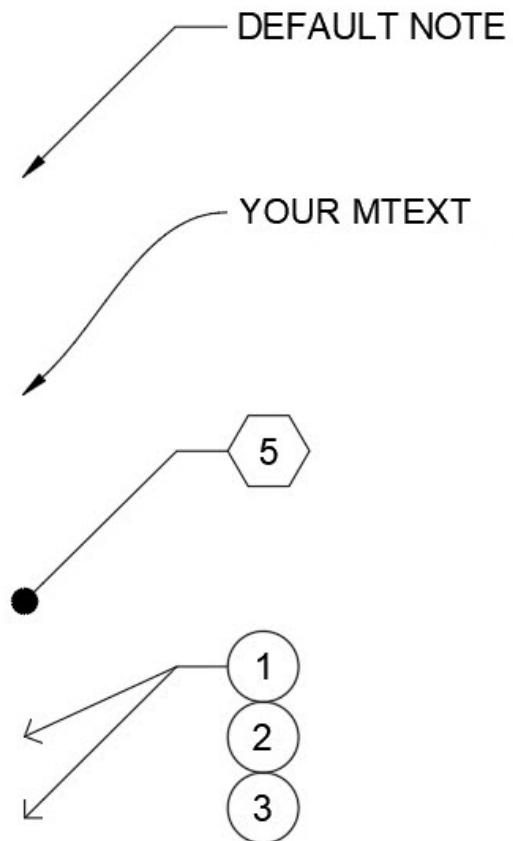

## Multileader Styles

**Easily manage your CAD standards by creating various Multileader Styles.**

All the settings for Multileaders are controlled by the Multileader Style. You can access the Multileader Style Manager from the Leaders panel in the Annotate tab of the Ribbon.

The dialog has three tabs which allow you to control the format, structure, and content of the style.

Now, you can make various styles for different tasks. You might have a style that uses a hex block for keynote callouts or set default text for standard notes that always read the same. Your options are almost endless, and they all start by creating Multileader Styles.

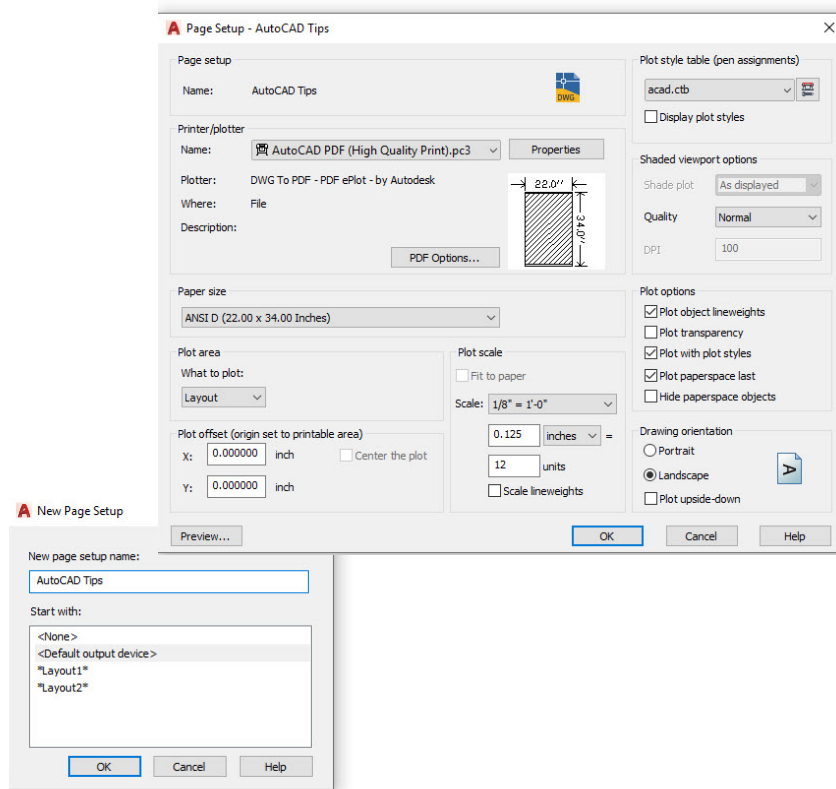

## Page Setups

**Speed up your time spent plotting and printing by utilizing Page Setups.**

Don't get bogged down by changing your plot settings when you need a different device or size. Improve your plot consistency by gathering all your print and plot settings into a named Page Setup.

To get started, right click on the desired Model Space or Layout tab and select Page Setup Manager.

Creating a new Page Setup is easy, as the interface is the same as the Plot dialog. Set what you normally would, like the plot device, size, area, style table, etc., to a single named Page Setup for fast recall.

Once it's saved in the drawing, you can easily import it into other drawings, saving even more time!



⚡ LEVEL 2

# UP YOUR GAME

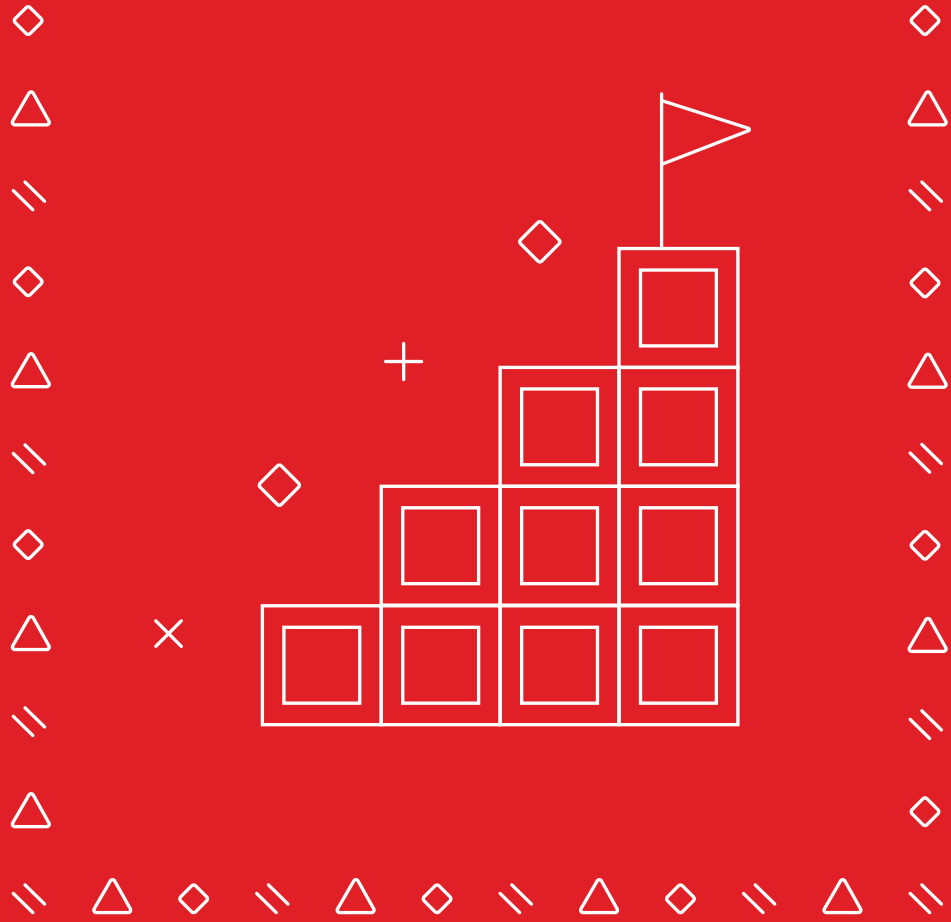

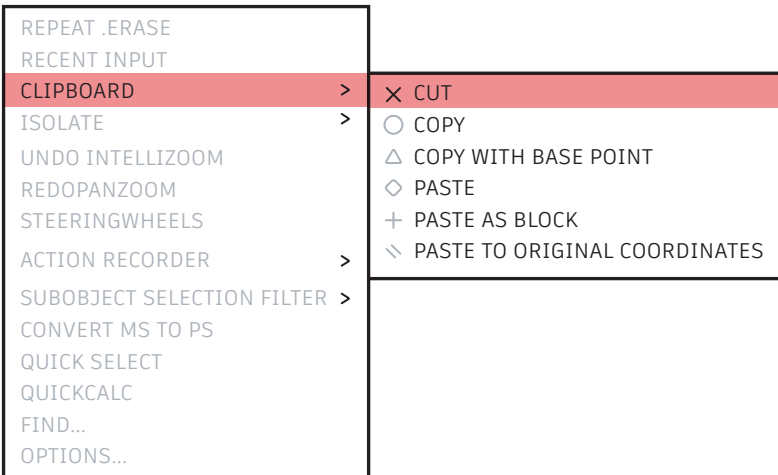
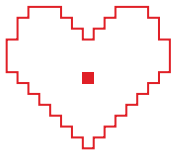
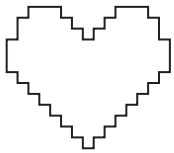
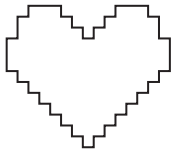

## Copy and Paste Options

**Copy and Paste like a pro by utilizing all the options available in AutoCAD.**

AutoCAD provides some special Cut, Copy, and Paste options, found in either the right click contextual pop-up menu or in the Clipboard panel of the Ribbon's Home tab. Keyboard shortcuts are also shown in the pop-up menu, for even faster access.

Some of the special options include being able to define the base point when selecting your entities, so that you can match the insertion point in your target drawing. You can then paste them as a Block, a Hyperlink, or to their original coordinates. The Ribbon also gives you access to the Paste Special command, useful if you're pasting spreadsheet data.

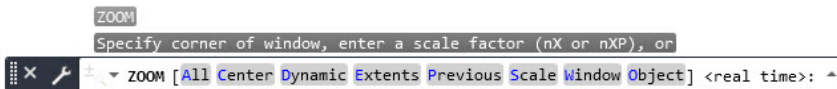
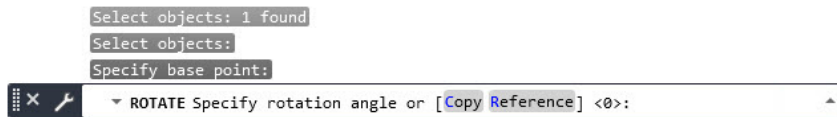
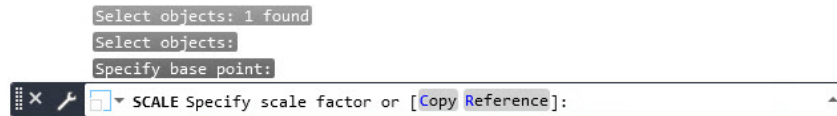

## Command Options

### Uncover additional functionality you may not be aware of in the Command Line.

Make sure to look at the Command Line while a command is in use. It will always prompt you for the correct input sequences and may provide various options for how to use it.

For example, both the Scale and Rotate commands have a Reference option, allowing you to use selected distances or angles. Fillet and Chamfer each have a Polyline option so you can edit all vertices of your Polyline with just one click. Even the Zoom command has options such as All and Extents.

Accessing these options is as easy as entering the highlighted hot key or by clicking on the option word. If you have Dynamic Input turned on, all the same options are available from within its pulldown menu.

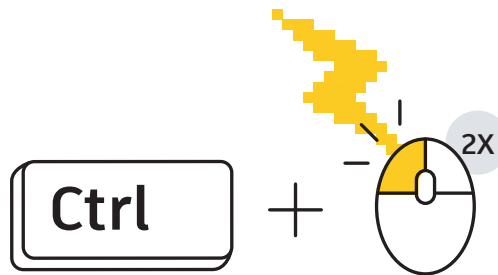
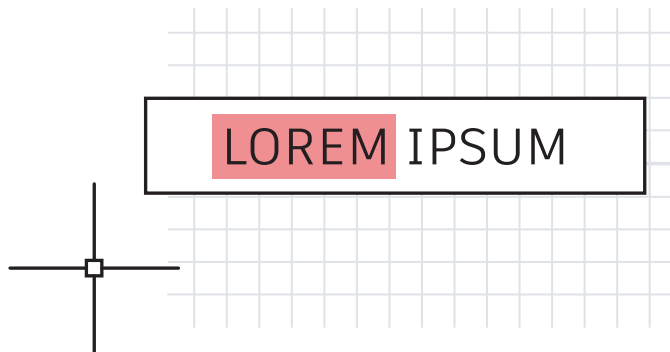

## Keyboard Combos

**Take advantage of AutoCAD keyboard shortcuts that can improve your productivity.**

Here are three to get you going:

- Bypass the Enhanced Attribute Editor to quickly edit an Attribute. Hold down the Control key when selecting the Attribute, and it will highlight similar to Single Line Text for editing.
- Clean up corners quickly using Fillet or Chamfer by holding down the Shift key when selecting the second object.
- Override any active Lock UI settings to move or close Palettes or Toolbars by holding down the Control key when selecting the object.

To reference all AutoCAD keyboard shortcuts, visit [autodesk.com/shortcuts/autocad](https://autodesk.com/shortcuts/autocad).

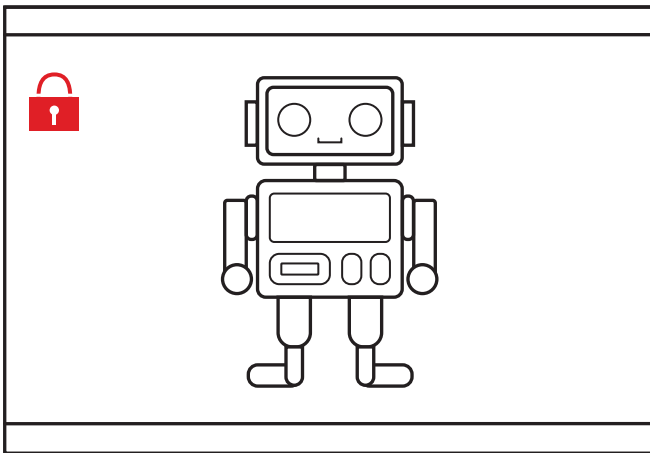
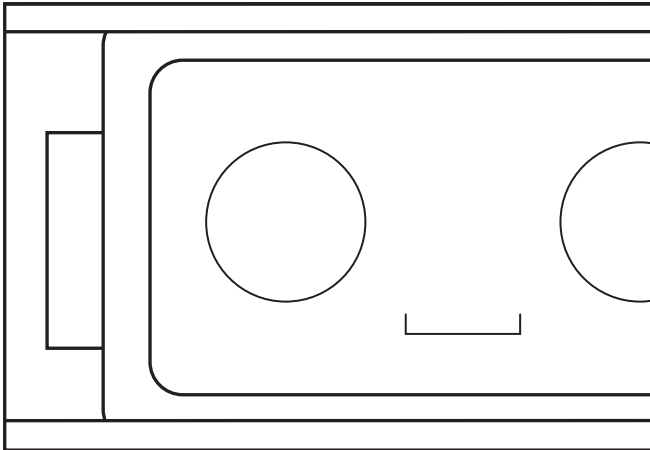

## Viewports

### Lock down your Layout Viewport settings to avoid accidental changes.

Don't let a Pan or a Zoom mess up your carefully constructed and scaled Layout Viewport. Once you have it right, *always* lock the Viewport.

Here are four ways to do so. The first three will require you to select the Viewport first.

1. Click on the Lock icon next to the Annotative Scale in the Status Bar (this is the easiest and most common method).
2. Right click, from the contextual popup menu, expand Display Locked and select Yes.
3. From the Properties Palette, set Display Locked to Yes.
4. From the contextual Layout Ribbon tab, in the Layout Viewports panel, select Lock from the pulldown menu item. This method will prompt you to select a Viewport if one is not already selected.



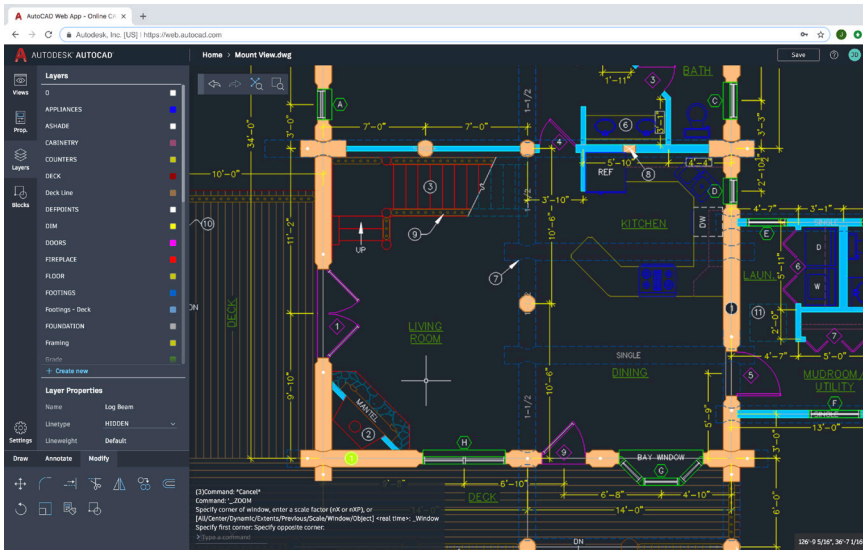

## AutoCAD on any Computer

**Access, edit, and design CAD drawings even when you're away from your primary workstation with the AutoCAD web app.**

Open a web browser and start designing in the AutoCAD web app on any computer – there's nothing to install.

Working in the AutoCAD web app is like working in AutoCAD desktop because the AutoCAD web app has Ribbon tools and a Command Line. You can get up and running quickly by going to [web.autocad.com](https://web.autocad.com) and signing in with your Autodesk ID.

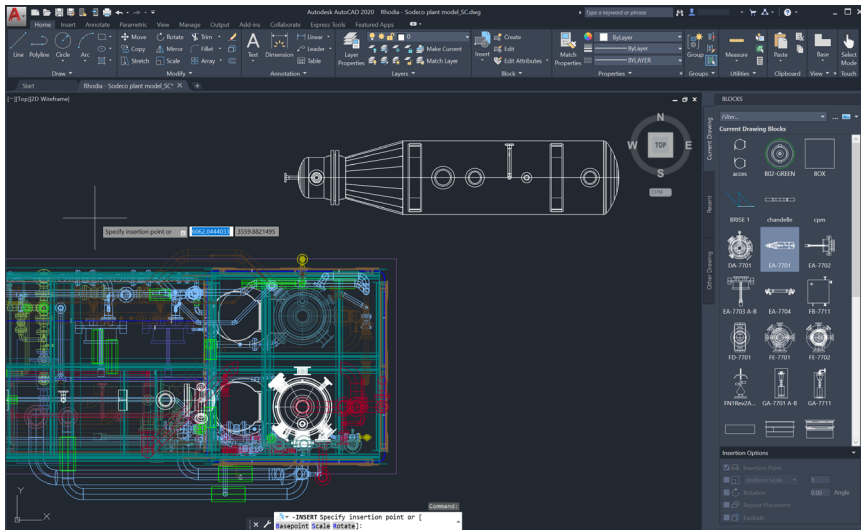

## Blocks Palette

### Insert Blocks more efficiently with the new Blocks Palette.

Easily find the Blocks you need with thumbnail icons that provide a preview of available Blocks to insert.

The Palette's three tabs allow you quick access to find the Block you need. You can find Blocks from the Current Drawing, from Libraries, or from those most Recently inserted.

No matter what tab you're working in, you'll still have access to all your familiar insertion options, such as scale, angle, rotation, etc. You can even check the Repeat Placement option to save additional steps.

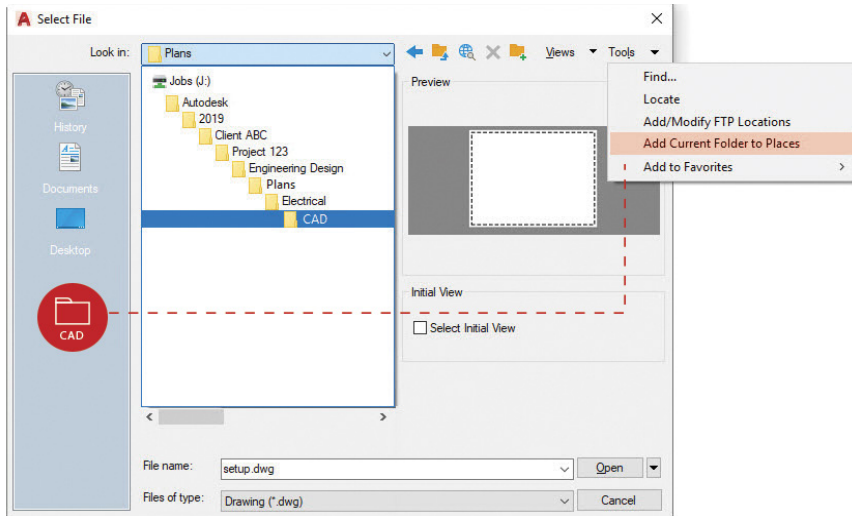

## Favorite Places

### Avoid endless project folder navigation by setting Places in the Open dialog.

Stop wasting time by continually navigating multiple levels of folders in the File Open dialog box. Once you get to your folder, add it as a new entry in the Places pane of the Open dialog.

Click on Tools in the upper right corner, then Add Current Folder to Places. A new icon will appear with the name of the folder. Now you can just click on your new Place to jump right to that folder.

**Bonus Tip:** If you find that you have multiple icons with the same name – “CAD” for instance – just right click on the icon, select Properties, and change the name to something that makes more sense, such as the project name.

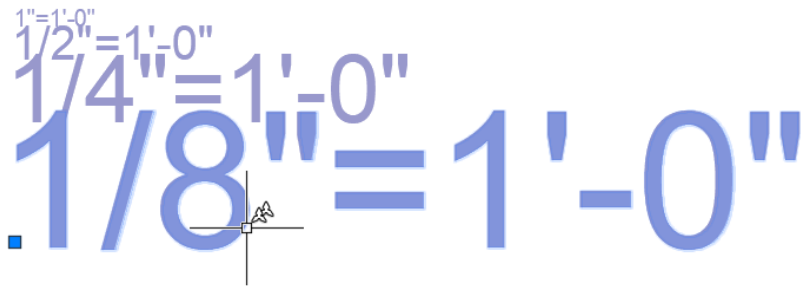

1"=1'-0"  
1/2"=1'-0"  
1/4"=1'-0"  
1/8"=1'-0"  
1'-0"

## Annotative Scaling

**Display the same object at different scales in Model Space or a Layout using the Annotative feature.**

When you set objects or Styles to be Annotative, the process of scaling them becomes automated for you. To automate scaling, select the Annotative checkbox in Style dialogs or set individual objects in Properties to be Annotative.

Annotative scales can be added to an object either by manually assigning them, or by allowing them to be added automatically by the viewport. Once the scales are added to the object, it will appear at the correct size for that scale. For example, your 3/32" height Text can scale properly in both a 1/4"=1'-0" viewport as well as a 1/8"=1'-0" viewport.

In addition to annotation objects such as Text, Mtext, Dimensions, Multileaders, and Attributes, Blocks and Hatches can be set to be Annotative as well.

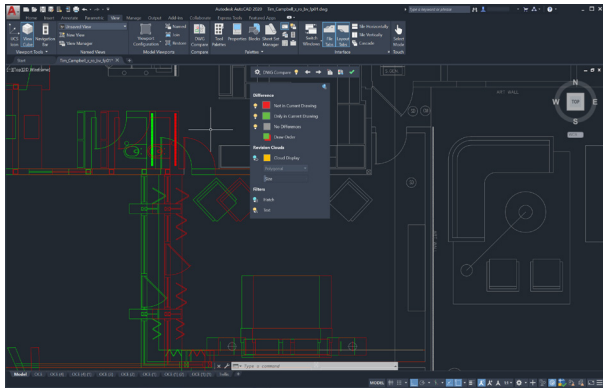

## DWG Compare

**Identify the differences between two drawing revisions with DWG Compare.**

DWG Compare allows you to quickly view the differences between drawings. All objects that are in both will show as gray, those not in the current drawing will be red, and those only in the current drawing will be green.

To continue your current editing session, you can toggle comparisons on or off, and any changes you make will reflect in the comparison in real time. You can even bring objects from your compared drawing into your current one!

DWG Compare can also insert Revision Clouds, which may speed up your change process by pre-defining color, style, and size preferences.

+ △ ◇ + △ ◇ + △ ◇ + △ +  
△ ⚡ LEVEL 3 △

**TAKE YOUR SKILLS  
TO THE NEXT LEVEL**



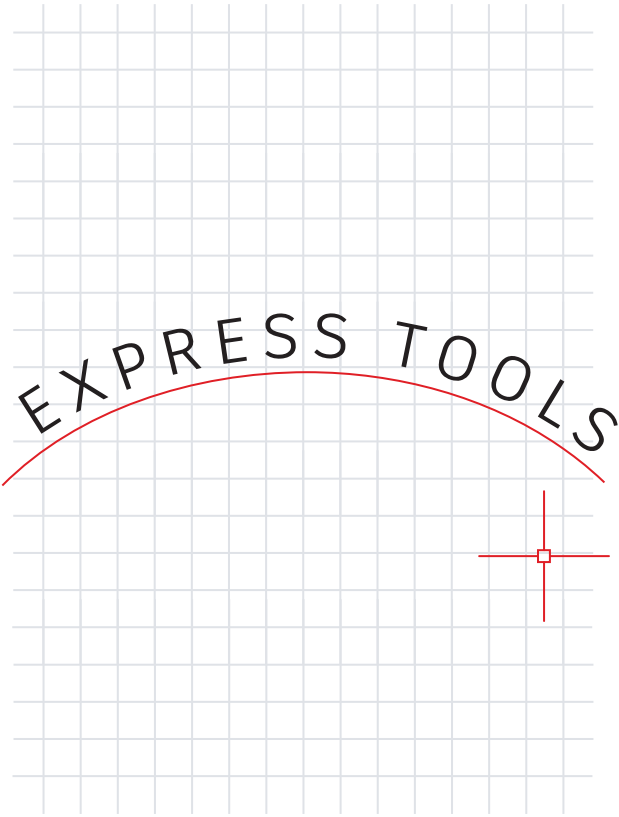

## Express Tools

**Take advantage of the extra functionality that the AutoCAD Express Tools provide.**

Express Tools extend the power of AutoCAD software, saving you time and enhancing your productivity. Most are found within the Express Tools Ribbon tab. They fall into various groups, such as Text, Layout, or Dimension tools, and each offers extended functionality for you.

Some user favorites include Move/Copy/Rotate, which allows you to perform three commands in one. The Burst command will explode Blocks and retain any Attribute information. There's even a command to let you align Text along a selected Arc!

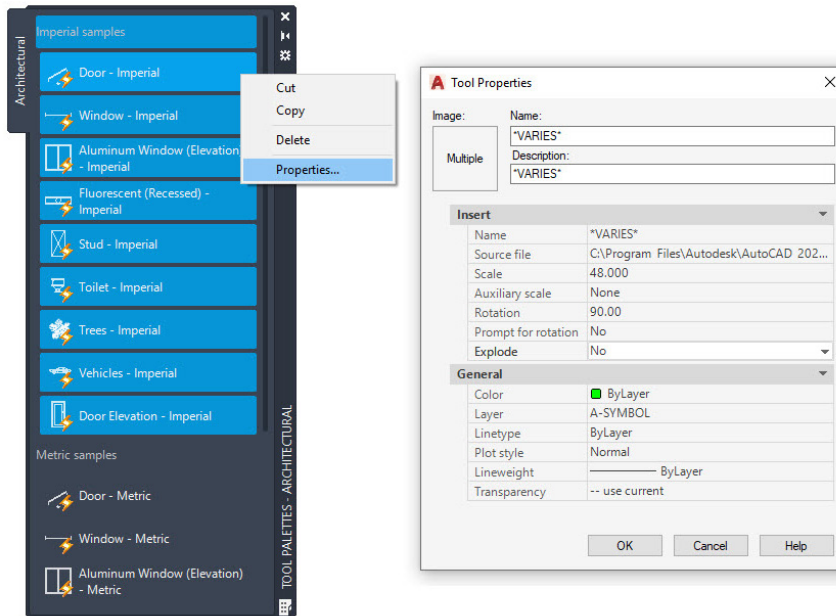

## Tool Palettes

**Set Block properties and behaviors from within your Tool Palettes to standardize your drawings.**

Enhance the insertion behaviors of your standard Blocks by defining their properties from within the Tool Palette. Simply right click on a Block, or multiple Blocks, and select Properties.

By pre-defining properties such as the insertion layer, scale, rotation (and more!), you can take control of ensuring your CAD Standards.



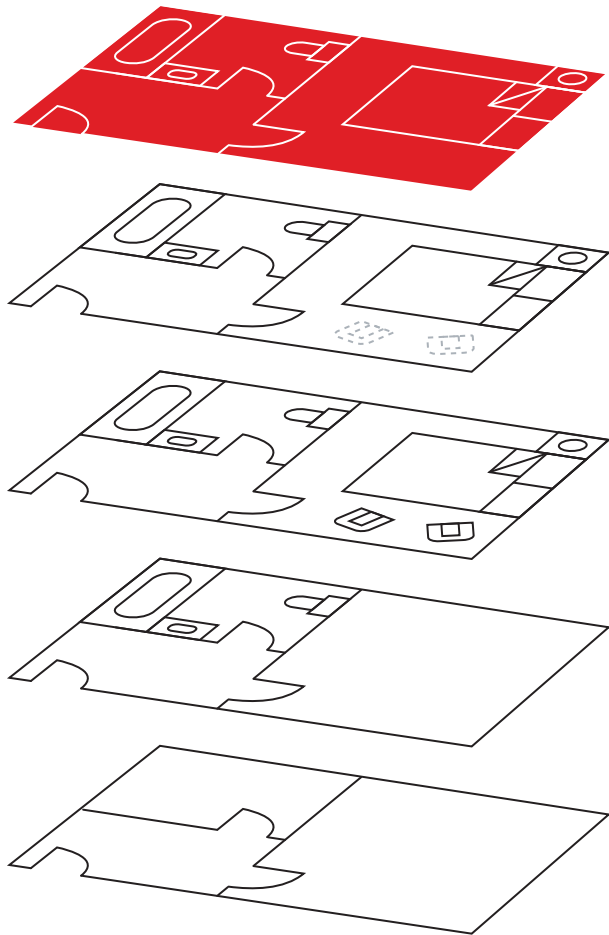

## Layer Filters

**Quickly display only the Layers you want using Layer Filters.**

Don't waste time and effort searching through hundreds (or more) of Layers for a small subset that you need. Find them once and create a Layer Filter.

With the tools found in the Layers Palette, you can create a Layer Filter from Layers you already have selected, or by creating queries based on properties or string values.

Once created, simply select the desired filter to see only those Layers you want.

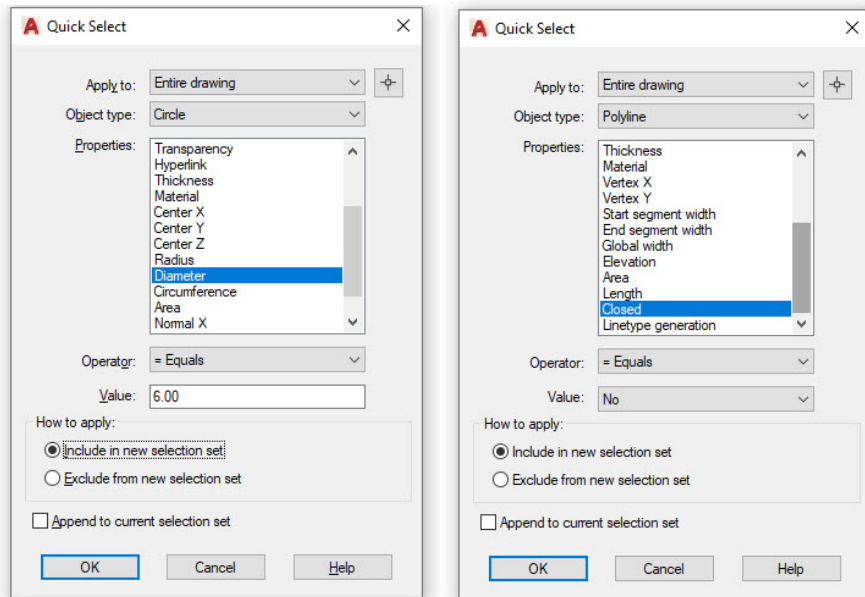

## Quick Select

### Use Quick Select to easily select multiple objects based on their properties.

Build powerful queries in the Quick Select dialog to quickly filter for just those objects you want. You can access Quick Select at any time from the right click pop-up menu.

Do you need to find every Circle with a diameter of 6.00? Every Polyline that is not closed? Every Block whose Z scale is greater than 1? All this and much more is easily done by using Quick Select.

Once all matching entities are found and selected, you can perform available edit commands, or change common properties on the entire set.

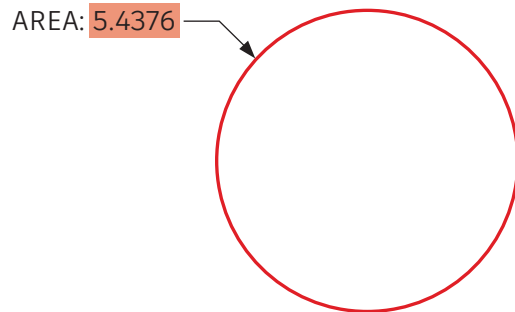
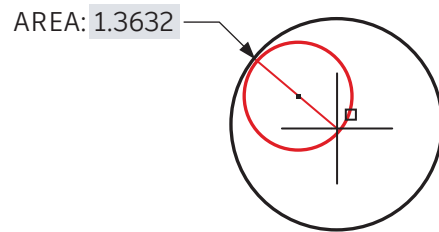

## Fields

### Insert Fields into Text or Attributes that may change over the course of your drawing's life.

Fields offer powerful flexibility in managing certain textual information. They are typically used where the annotation is not static, as they get their information from entity data within the drawing, or from system data.

Imagine a scenario where you have a note that calls out the area of a region. By setting a Field in the note, if the region changes shape, the Field will automatically update to reflect the change.

Fields are also commonly used in Title Blocks and Plot Stamps, displaying changing information such as dates, times, or usernames.

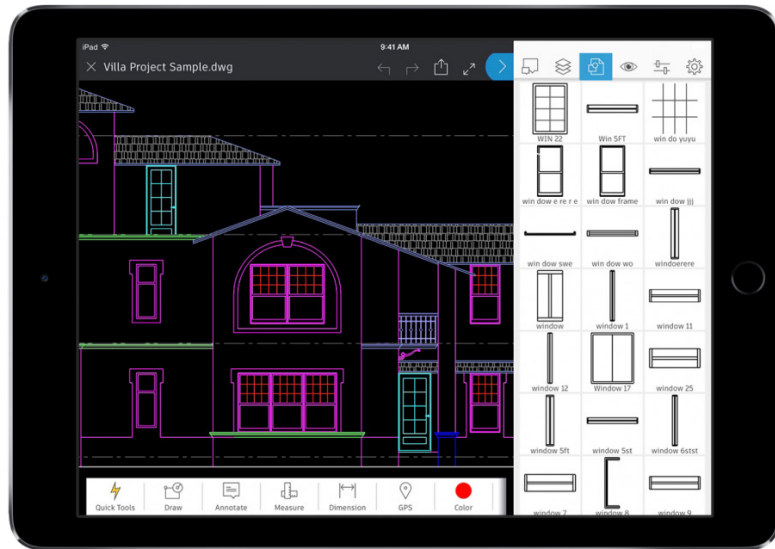

## AutoCAD Wherever You Go

**Edit and reference your CAD files in the field and on the go with the AutoCAD mobile app.**

Use the AutoCAD mobile app to access your latest drawings on your smartphone or tablet to view, edit, and create DWGs at the jobsite and beyond.

Simply download the free AutoCAD mobile app to your mobile device via the app store and sign in with your Autodesk ID. You'll automatically be upgraded to the Premium version of the app.

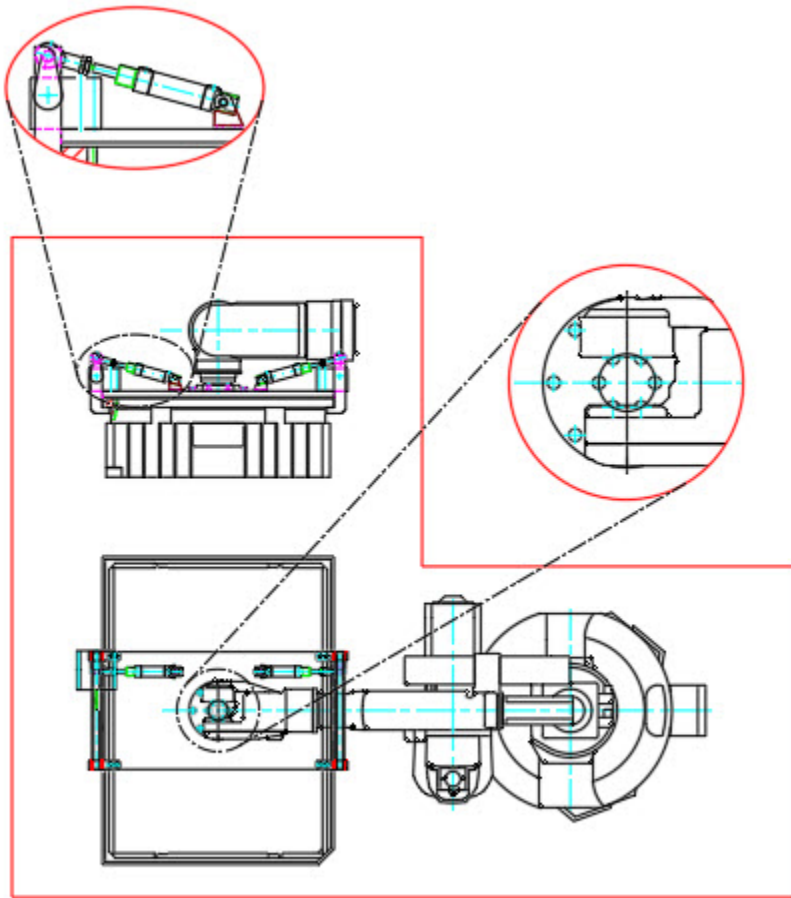

## Nonrectangular Viewports

**Boost your Layouts flexibility by creating non-rectangular Viewports.**

Know your options when it comes to creating Layout Viewports. Most of the time, a rectangle is fine, but you can make Viewports of almost any shape. One way is to use the Polygonal option from the Ribbon and create it as you would a Polyline.

For even more power, you can turn most closed objects into a Viewport using the Object option. This method allows you to turn a Polyline, Circle, Ellipse, or even a Polygon into a Layout Viewport.

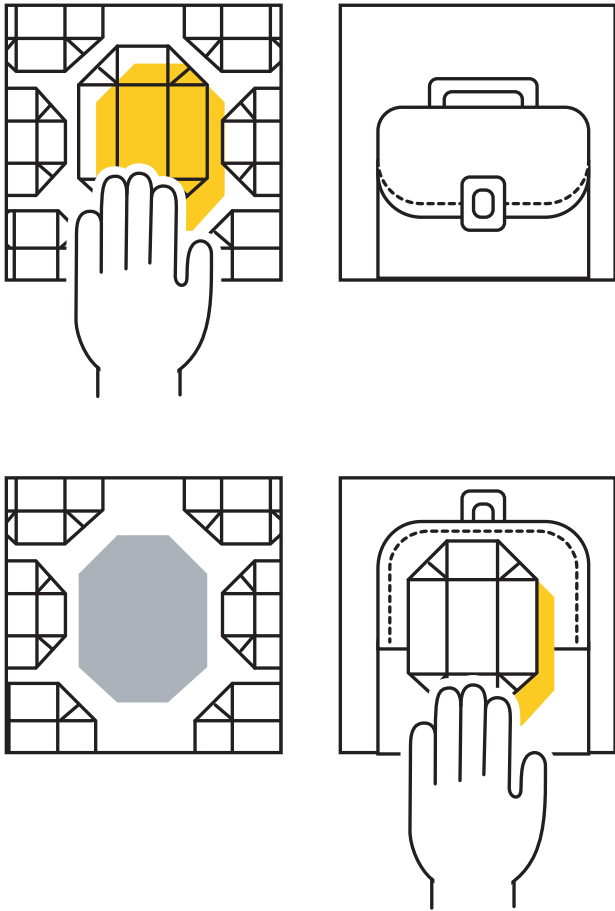

## Copy Nested Objects

**Speed up your workflow by copying objects from your external references with the Copy Nested Objects command.**

When you need to copy objects from an Xref into your drawing, cut out the overhead of opening the Xref, copying to the clipboard, closing that file, then pasting it in.

Instead, use the Copy Nested Objects command. It's found in the additional tools pulldown of the Modify panel of the Ribbon. It allows you to reach directly into the Xref to select the objects to copy.

**Bonus Tip:** Eliminate the need to open the Block Editor as Copy Nested Objects works on Blocks too.

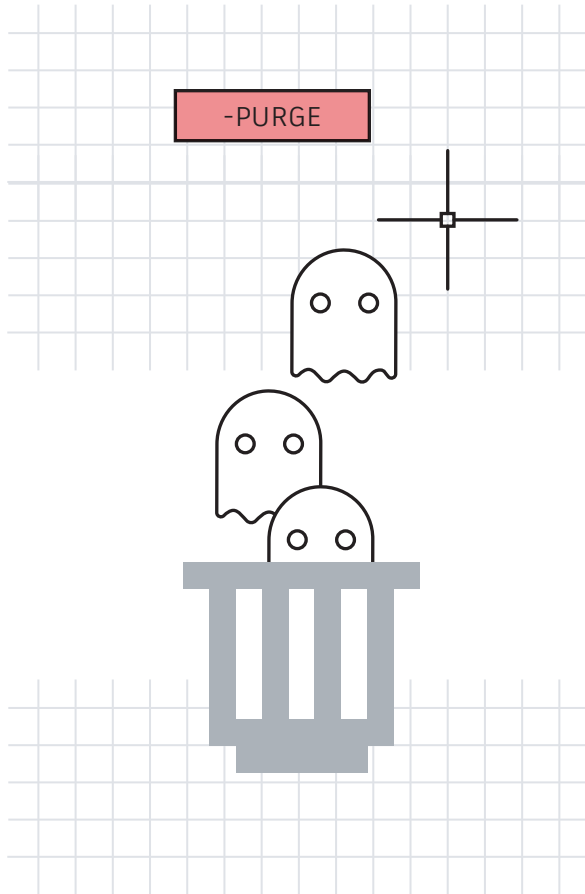

## Purge and Audit

**Keep your drawing files at peak efficiency by eliminating unused and potentially harmful data.**

Make sure to run the Purge command often and the Audit command on occasion to keep it clean.

Take advantage of the redesigned Purge command that can help you easily manage non-purgeable items and remove multiple unneeded items all at once. Also, occasionally run the Command Line version (-Purge) and choose the Regapps option (not found in the dialog box of the standard PURGE command), which will remove the application definitions for objects or programs that are no longer present.

When running Audit, make sure you respond Yes when prompted to “fix any errors detected”.



⚡ LEVEL 4



**POWER UP!**

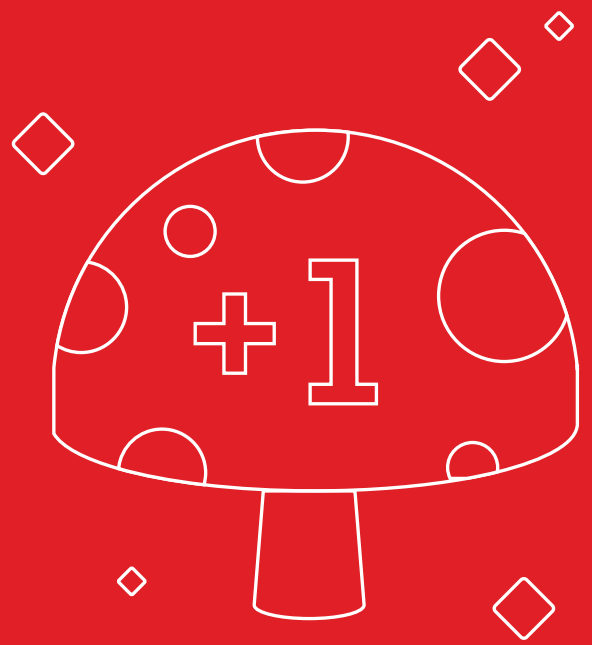



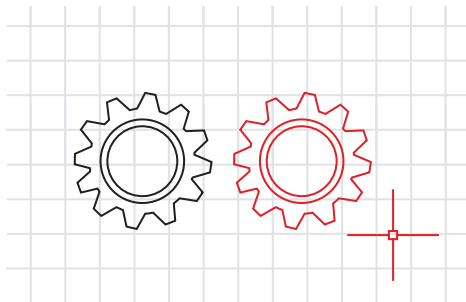
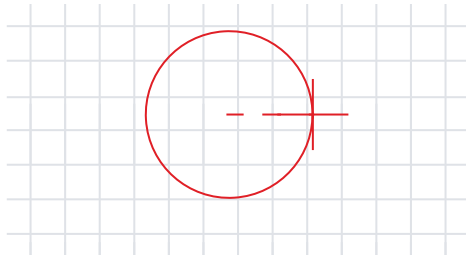

## Alias Editor

### Customize command aliases to better suit you with the Alias Editor.

It's easy to make changes to the command aliases already provided in AutoCAD. We're all different, so if your mind thinks "C" is Copy instead of Circle, feel free to change it.

Launch the Alias Editor from the Tools panel of the Express Tools. The dialog box provides an easy interface to Add, Remove, or Edit command aliases. Find either "C" or Circle in the list, click Edit, and re-map it to match your preference.

If one of your favorite commands doesn't have an alias, you can add it. For example, you may find yourself using PDF Import often. Just use the Add button, choose your new alias, and map it to the PDFIMPORT command.

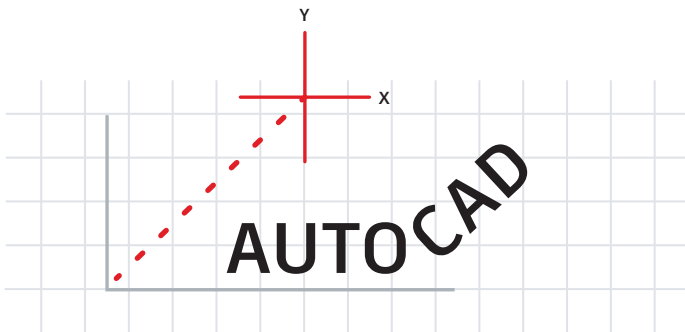
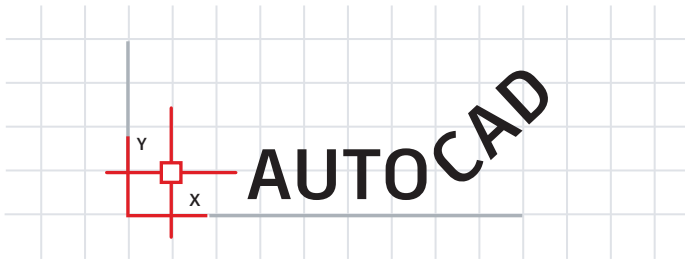

## User Coordinate System

**Leverage the User Coordinate System (UCS) Icon to reorient your drawing for easier drafting.**

There are several ways to change the angle that you are drawing on, but one of the simplest is to quickly change your UCS. The UCS Icon is an actual object with its own functional Grips.

Click on it, then select the Move Grip to place it onto an angled object. Once attached, click on the round end Grip, and rotate it about the Z axis to align it with your object. Now you can quickly create your geometry in relation to your desired angled object.

When you're done, it's easy to set it back. Select the icon again, right click, and choose World from the popup menu.

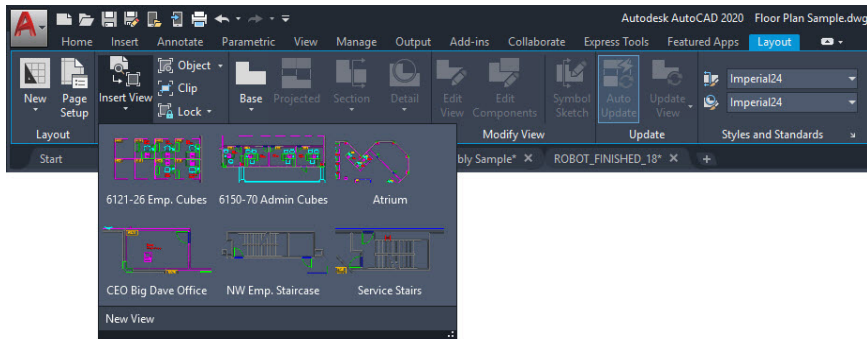

## Named Views

**Eliminate extra steps by using Named Views to quickly create Layout Viewports.**

Found in the Layout tab of the Ribbon, the Insert View tool will display a gallery of all named Model Space Views. Click the View you want and drag it onto your Layout.

It will scale itself to the view's Annotation Scale. If you prefer, you can right click to set a scale before dropping the View into your Layout, or once placed, use the triangular Scale Grip to select your scale.

This method saves you the important step of locking the Viewport, as it does it automatically for you!

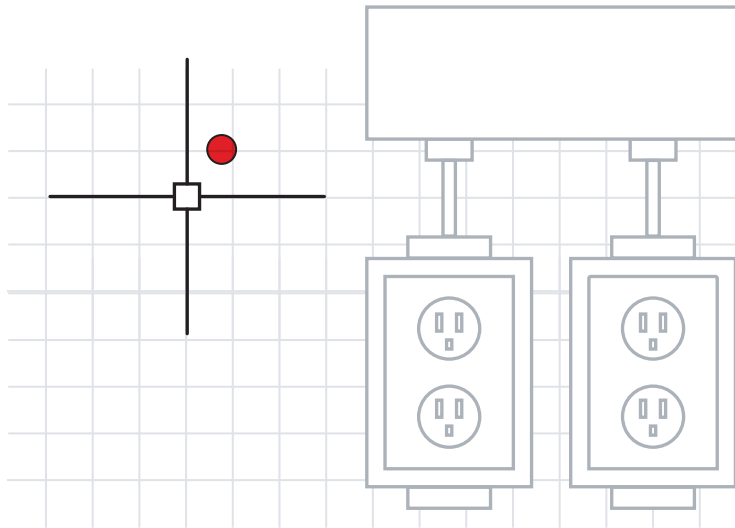
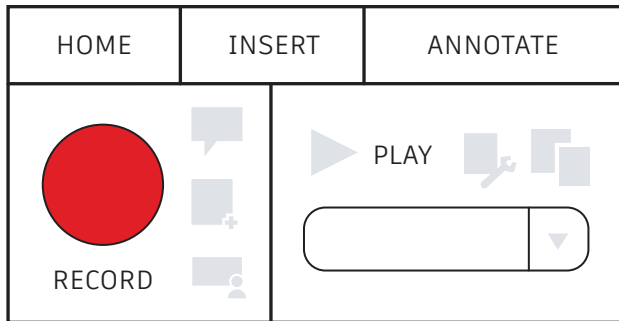

## Action Recorder

### Automate your repetitive tasks using the Action Recorder.

True productivity is often a function of automating command sequences. The best place to start may be with the Action Recorder to automate your workflows.

Found in the Manage panel of the Ribbon, the recorder creates named macros that you can use to recreate a command sequence. It's as easy as hitting the big Record button, executing your commands, then stopping the recording.

Once recorded, play back the macro, and watch those commands perform themselves!

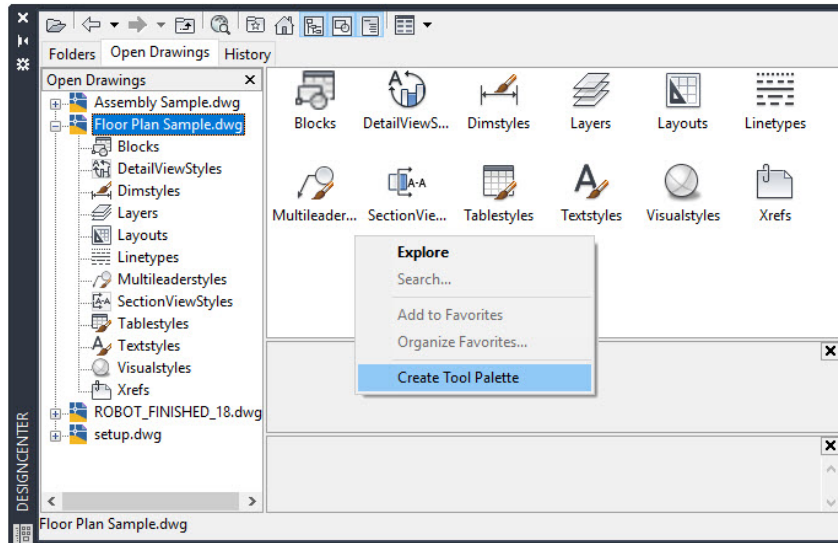

## Design Center

### Access content in other drawings, or easily create Tool Palettes with Design Center.

You can use Design Center to import almost any content from other drawings, such as Styles, Layouts, and Xrefs. You can find it as one of the small icons in the Palette panel of the Ribbon's View tab, or you can simply use its keyboard alias, DC.

Just navigate to the drawing (or often more conveniently, any open drawing), and drill down to the content you need. Often, using Design Center can be more efficient than recreating content or re-attaching Xrefs.

In addition, there's no easier way to create a Tool Palette from a drawing that contains your Block library. Simply right click in the content pane and select Create Tool Palette.

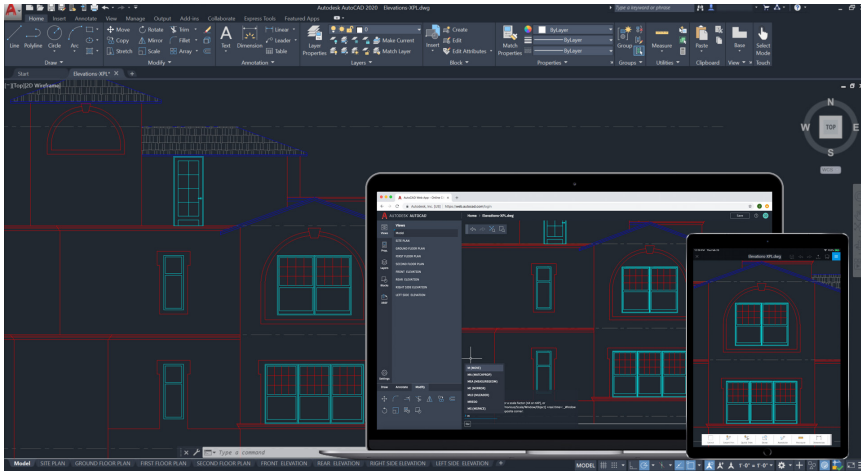





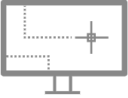
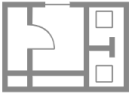

## Draft in AutoCAD across Desktop, Web, and Mobile

Ever need to take your drawings with you? With AutoCAD on desktop, web, and mobile, you can access and edit your files anytime, anywhere, on any device.

Stay connected to your drawings with the AutoCAD and the AutoCAD web and mobile apps. Use the Save to Web and Mobile feature to save drawings from your desktop to view and edit on the AutoCAD web and mobile apps, Xrefs included. Easily go from drafting on your desktop to drafting on the AutoCAD web and mobile apps and vice versa.

**Bonus Tip:** You can open DWG files directly in the AutoCAD web and mobile apps with Autodesk's cloud, as well as with Microsoft OneDrive, Box, and Dropbox.

 AUTOCAD	 ARCHITECTURE TOOLSET	 ELECTRICAL TOOLSET	 MECHANICAL TOOLSET
 MEP TOOLSET	 MAP 3D TOOLSET	 RASTER DESIGN TOOLSET	 PLANT 3D TOOLSET

## AutoCAD Specialized Toolsets

**Speed up your work with Specialized Toolsets that focus on the needs of various industry sectors.**

Significantly reduce the time it takes to produce your industry designs. By using the intelligent objects, styles, parts, features, and symbols found in the toolsets, you can be more productive with less effort.

There are seven specialized toolsets to choose from: Architecture, Mechanical, Electrical, MEP, Plant 3D, Map 3D, and Raster Design.

- **Architecture toolset:** Provides intelligent objects such as walls, doors, and windows that recognize their relationship to each other, and ease the tasks of producing sections, elevations, and schedules.
- **Mechanical toolset:** Includes over 700,000 intelligent manufacturing parts which also connect to pertinent project information. Any change on one component will cause an automatic update on all related to it.
- **Electrical toolset:** By using smart schematic lines and symbology, you can expect up to a 95% savings in original design and revision time. Continue to leverage this data to create reports and BOMs fast, accurately, and automatically.

Learn more about the specialized toolsets at [autocad.com](https://autocad.com) or download them directly from your Autodesk Account.



## Make the Winning Moves

**Learn to resolve issues on your own and know where to find answers quickly.**

Power users can often fix problems themselves. It's important to know your options in case of a crash or file corruption. If your file won't open, you may need to use Recover instead of Open, which will Audit the file as it's opening. If you have Xrefs in the file, use the Recover All option to get those too.

In case of a crash, make use of the Drawing Recover Manager. It should appear showing your crashed file and its autosave version. If not, find the autosave file path in Options. Navigate to the file and change its extension from .sv\$ to .dwg.

Finally, answer your own questions with several resources, including the AutoCAD Help menu, the [Autodesk Knowledge Network](#), and the [AutoCAD blog](#).



**This book is made possible by a number of AutoCAD power users including Frank Mayfield and other contributors to the AutoCAD blog.**

*Some features mentioned in this book, including Quick Measure and Blocks Palette, are available starting in AutoCAD 2020.*

*Autodesk makes software and services available on a licensed or subscription basis. Rights to install, access, or otherwise use Autodesk software and services (including free software or services) are limited to license rights and services entitlements expressly granted by Autodesk in the applicable license or service agreement and are subject to acceptance of and compliance with all terms and conditions of that agreement. When you subscribe to a plan, it may renew automatically for a fixed fee on a monthly or annual basis, subject to availability. All benefits and purchase options may not be available for all software or services in all languages and/or geographies. Access to cloud services requires an Internet connection and is subject to any geographical restrictions set forth in the Terms of Service.*

*Autodesk, AutoCAD, and the Autodesk logo are registered trademarks or trademarks of Autodesk, Inc., and/or its subsidiaries and/or affiliates in the USA and/or other countries. All other brand names, product names, or trademarks belong to their respective holders. Autodesk reserves the right to alter product and services offerings, and specifications and pricing at any time without notice, and is not responsible for typographical or graphical errors that may appear in this document. © 2019 Autodesk, Inc. All rights reserved.*

